

Wintal[®]

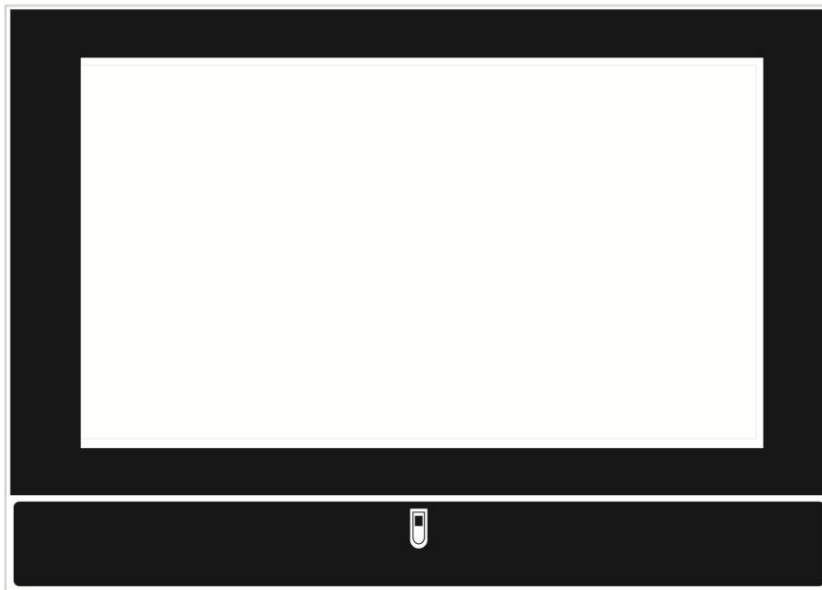

26-32" LCD OPERATING MANUAL LCD-TV

PLEASE KEEP THIS OPERATING MANUAL FOR FUTURE REFERENCE

CONTENTS

1	PREFACE	2
2	SAFETY PRECAUTIONS	2
3	FRONT & BACK VIEW, REAR CONNECTION OF LCD	3
4	TV INSTALLATION DRAWINGS	4
	4.1 ANTENNA CONNECTION	4
	4.2 AV1 INPUT CONNECTION	4
	4.3 AV2 INPUT CONNECTION	4
	4.4 S-VIDEO CONNECTION	5
	4.5 YPbPr CONNECTION	5
	4.6 PC INPUT CONNECTION	5
	4.7 HDMI INPUT CONNECTION	6
	4.8 AV OUPUT CONNECTION	6
	4.9 COAXIAL CONNECTION	6
5	CONFIGURATION OF THE LCD	7
	5.1 PICTURE SETTING	7
	5.2 SOUND SETTING	8
	5.3 CHANNEL SEARCH	8
	5.4 OPTION SETTING	9
	5.5 TIME SETTING	9
	5.6 LOCK SETTING	10
6	REMOTE CONTROL INSTRUCTIONS	11-12
7	REMOTE CONTROL SETUP	13
	7.1 BATTERY USAGE CAUTION	13
8	ACCESSORIES	13
9	TROUBLE SHOOTING AND ADVICE	14
10	SPECIFICATIONS	15

1 PREFACE

Thank you for purchasing this LCD TV! This manual will help you use all the extensive features of your new TV. Make sure the monitor was not damaged in transit. Should the monitor be damaged, do not install it and contact your dealer. Check that you have all the accessories according to the model.

2 SAFETY PRECAUTIONS



Put the monitor on a stable surface.

Do not use the monitor with other fixations than those provided or suggested by the manufacturer.

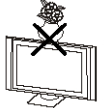

Do not place any material on the monitor.

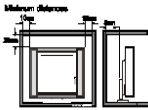

If you have a wall mount, check that it is steady.

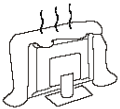

Do not block or cover the ventilation openings on the monitor.

Power source

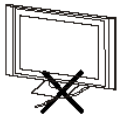

The monitor must be plugged to a power source of 100-240V and 50/60 Hz.

Connection cables

Power cord and cables must be properly routed and protected to prevent people from stepping on them and causing the monitor to fall.

Heating sources and humidity

Keep the monitor dry and away from humidity.

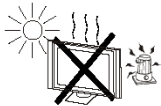
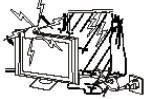

Keep the monitor away from heat sources.

Cleaning and maintenance

Unplug the monitor before cleaning it. Do not use solvents or liquids to clean the monitor. Only clean the monitor with a soft and dry cloth.



In case of troubleshooting, do not use spare parts other than those suggested by the manufacturer. Using incorrect spare parts can lead to electric shocks, short-circuits, fire, or other incidents.

Departure in holidays

Unplug the TV during lightning storms or when unused for long periods of time.



3 FRONT & BACK VIEW, REAR CONNECTION OF LCD

Front View

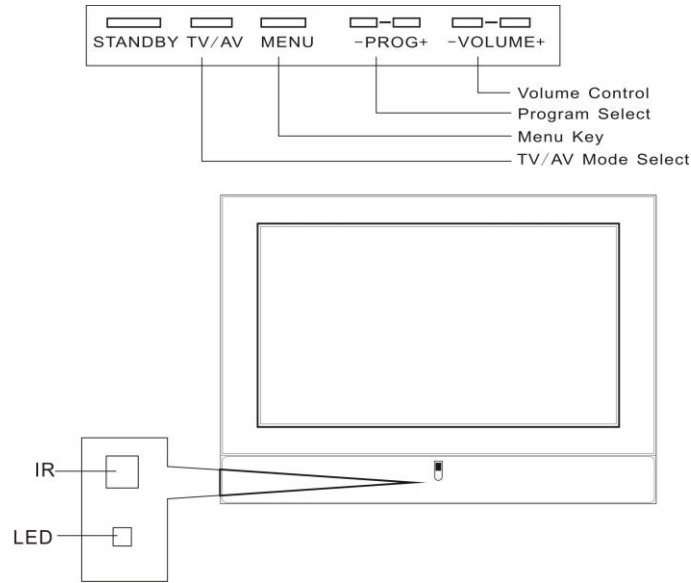

Back View

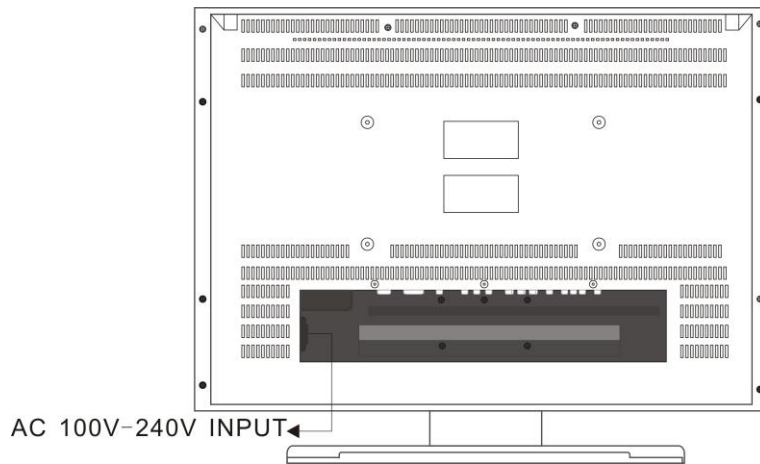

Rear Connection

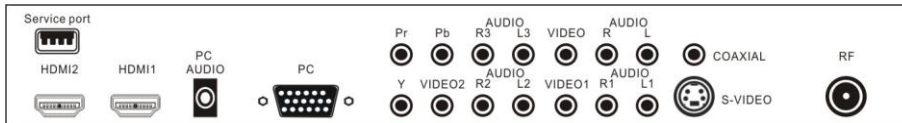

Note : The Service port interface is only for updating TV software.

4 TV INSTALLATION DRAWINGS

4.1 ANTENNA CONNECTION

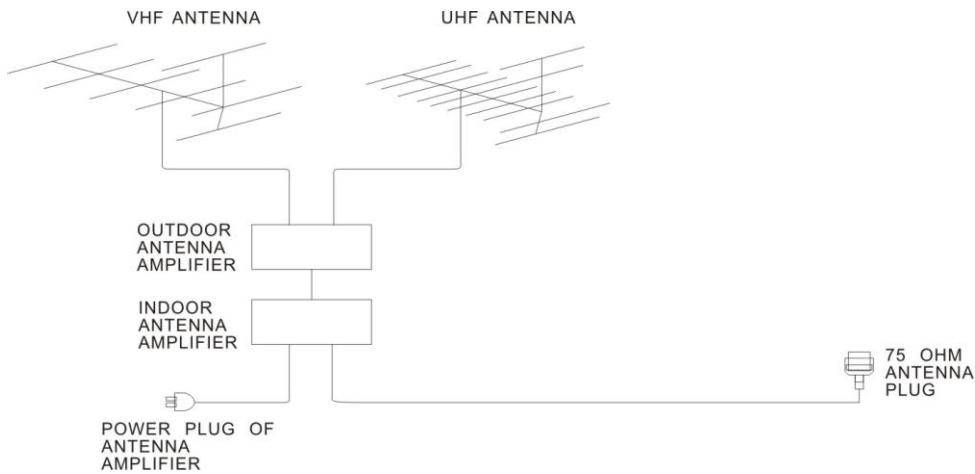

To ensure good picture and sound, TV antenna system needs to be installed. The antenna system as shown can be sourced from TV equipment shops, which will provide service for correct installation and connection. After installation, insert the 75-ohm antenna plug into the antenna jack as show in case of signal of closed circuit TV,

4.2 AV 1 INPUT CONNECTION

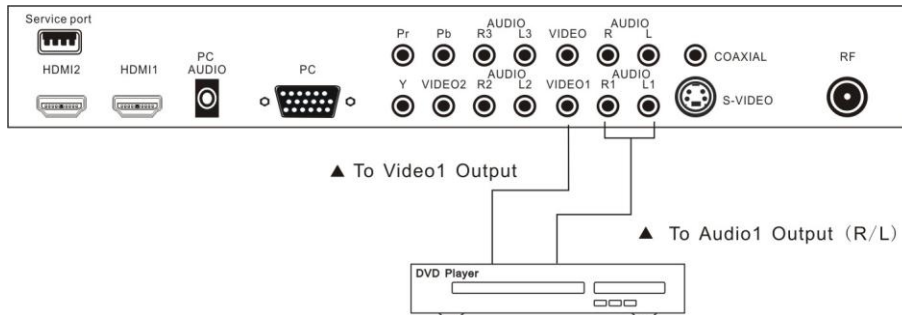

4.3 AV 2 INPUT CONNECTION

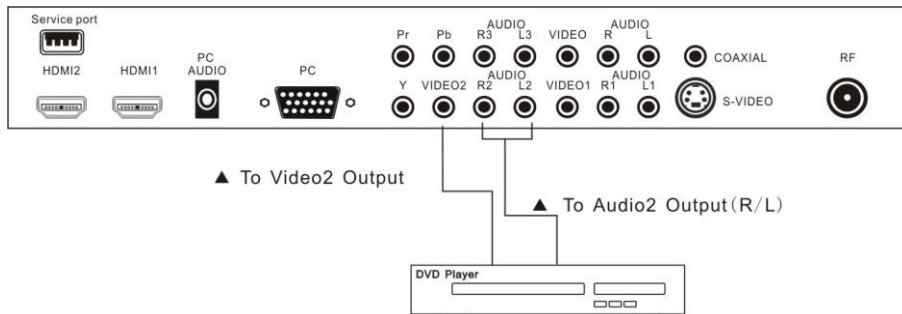

4.4 S-VIDEO INPUT CONNECTION

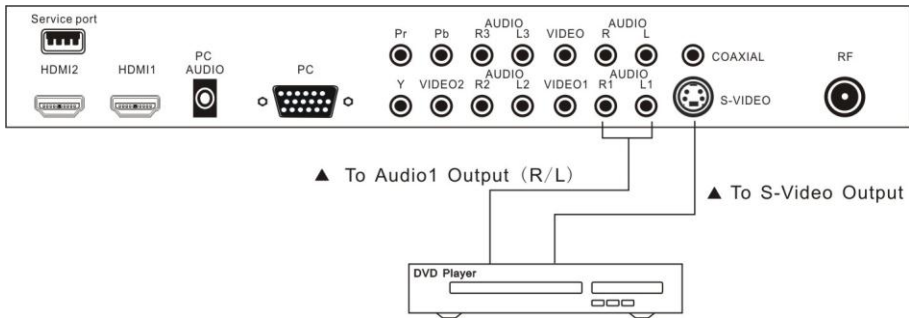

4.5 YPbPr INPUT CONNECTION

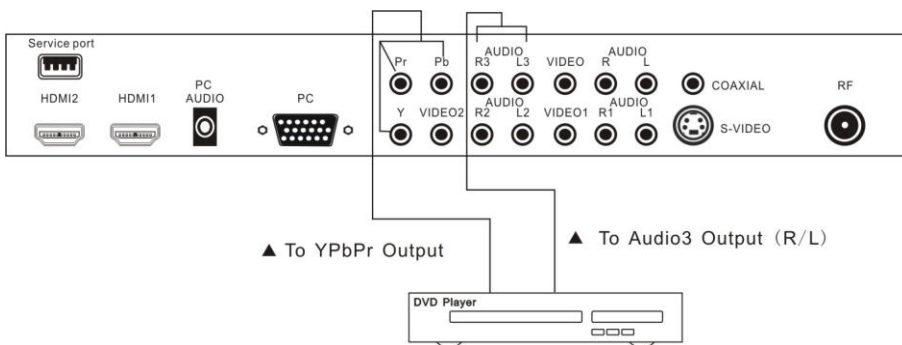

4.6 PC INPUT CONNECTION

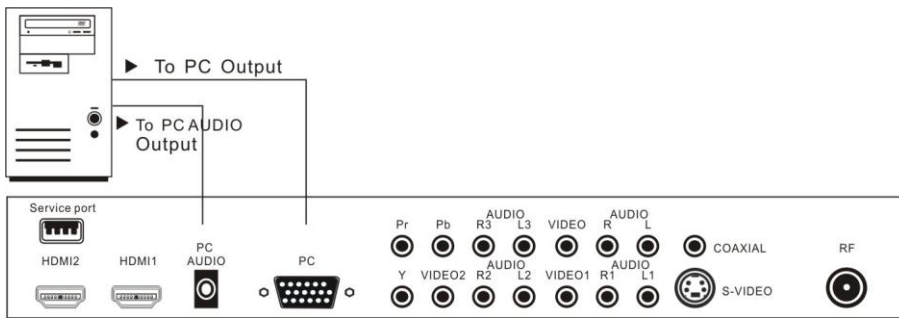

4.7 HDMI INPUT CONNECTION

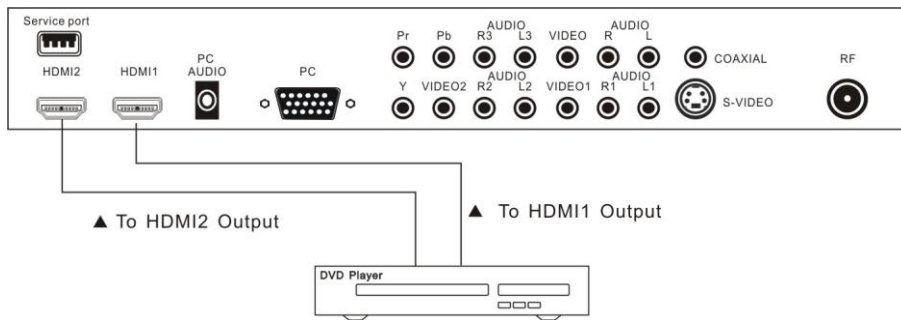

4.8 AV OUTPUT CONNECTION

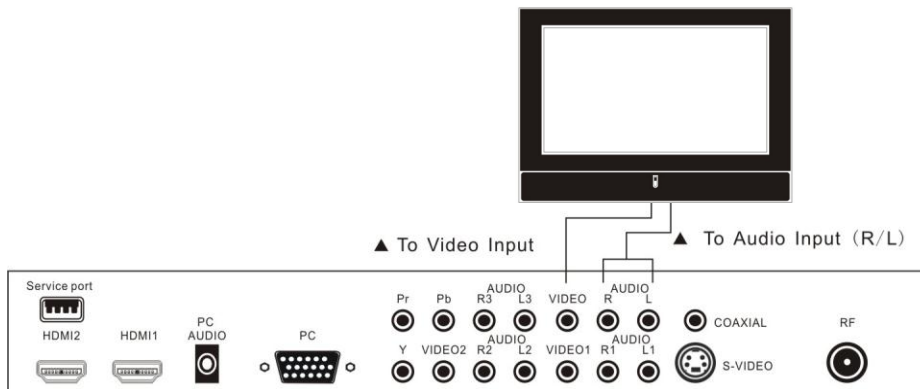

4.9 COAXIAL CONNECTION

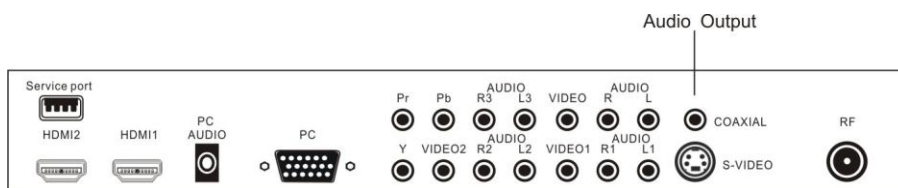

5 CONFIGURATION OF THE LCD

5.1 PICTURE SETTING

5.1.1 Press <SYS MENU> key, then press ◀ or ▶ key until the screen displays as below.

a) Press ▼ and enter Picture Setting Menu. Press ▲ or ▼ key and enter Picture Mode > Contrast > Brightness > Colour > Sharpness > Tint

b) Press ◀ or ▶ key to access and adjust Picture Mode > Contrast > Brightness > Colour > Sharpness > Tint

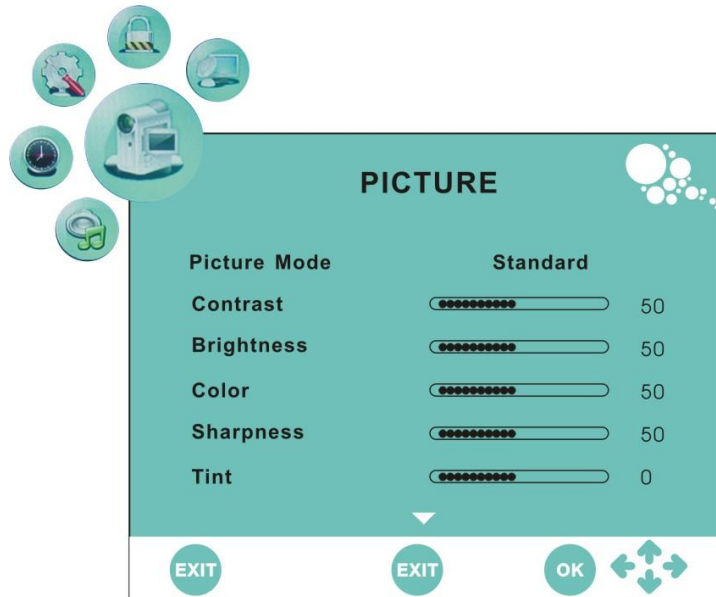

5.1.2 Press <SYS MENU> key, then press ◀ or ▶ key until the screen displays as below.

a) Press ▼ and enter Picture Setting Menu. Press ▲ or ▼ key and enter Colour Temperature > Red > Green > Blue > Aspect Ratio > Noise Reduction

b) Press ◀ or ▶ key to access and adjust Colour Temperature > Red > Green > Blue > Aspect Ratio > Noise Reduction

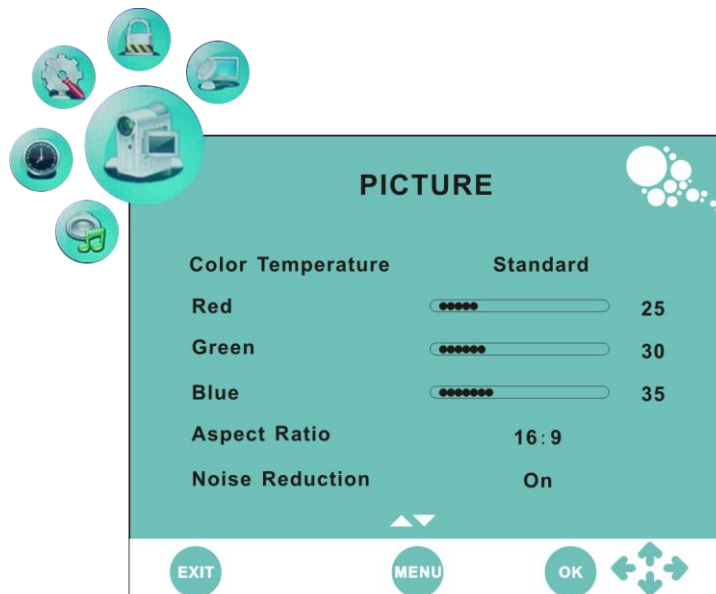

5.2 SOUND SETTING

Press <SYS MENU> key, then press ◀ or ▶ key until the screen displays as below.

a) Press ▼, and then enter Sound Setting Menu. Press ▲ or ▼ key to enter Sound Mode > Treble > Bass > Balance > Auto Volume > Surround Sound.

b) Press ◀ or ▶ Key to access and adjust Sound Mode > Treble > Bass > Balance > Auto Volume > Surround Sound.

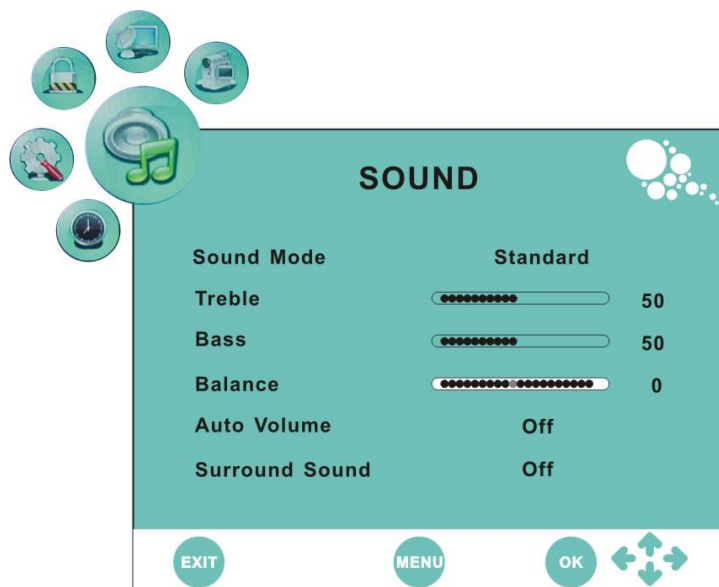

5.3 CHANNEL SEARCH

Press <SYS MENU> key, then press ◀ or ▶ key until the screen displays as below.

a) Press ▼, and then enter channel Setting Menu. Press ▲ or ▼ key and enter Auto Tuning > DTV Manual Tuning > ATV Manual Tuning > Programme Edit.

b) Press ◀ or ▶ Key to access and adjust Auto Tuning > DTV Manual Tuning > ATV Manual Tuning > Programme Edit.

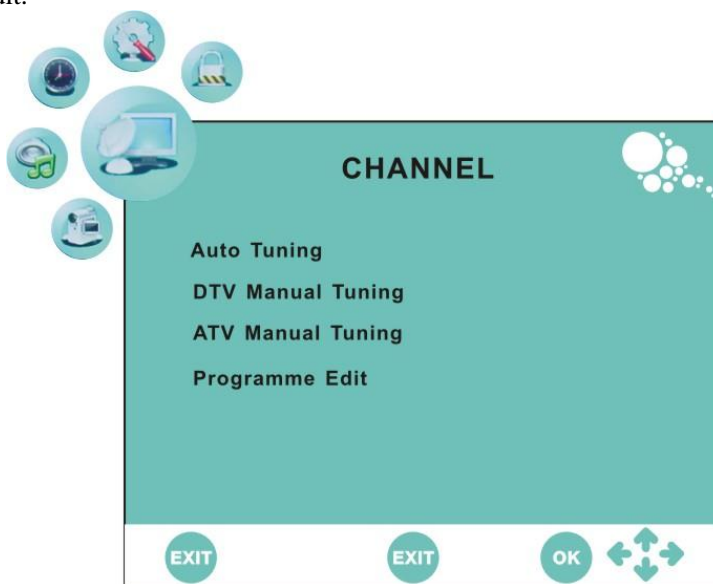

5.4 OPTION SETTING

Press <SYS MENU> key, then press ◀ or ▶ key until the screen displays as below.

a) Press ▼, and then enter option Setting Menu. Press ▲ or ▼ key and enter Language > Audio Languages > Subtitle Language > Country > Restore Factory Default.

b) Press ◀ or ▶ Key to access and adjust Language, Audio Languages > Subtitle Language > Country > Restore Factory Default.

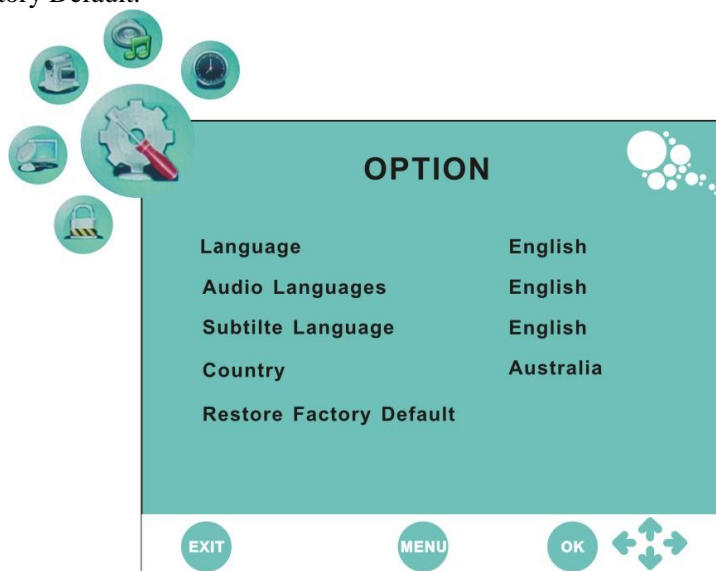

5.5 TIME SETTING

Press <SYS MENU> key, then press ◀ or ▶ key until the screen displays as below.

a) Press ▼, and then enter Time Setting Menu. Press ▲ or ▼ key and enter Date/Time > Off Time > On Time > Sleep Timer > Auto Standby > Time Zone.

b) Press ◀ or ▶ Key to access and adjust Date/Time > Off Time > On Time > Sleep Timer > Auto Standby > Time Zone.

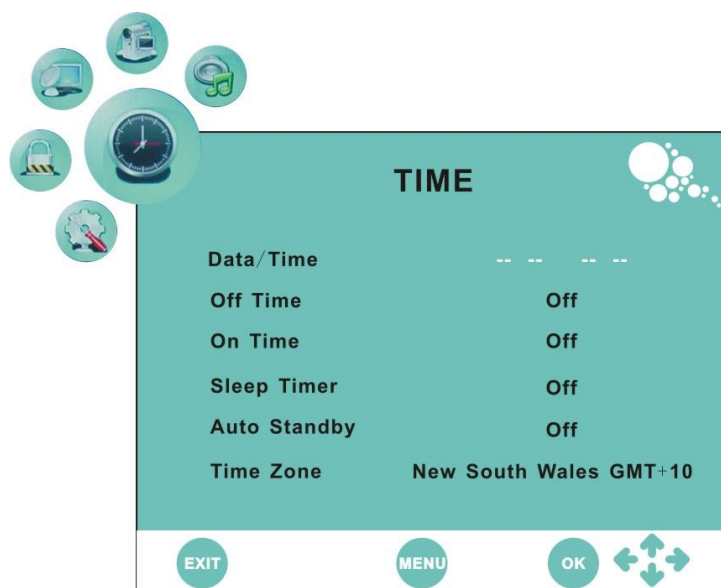

5.6 LOCK SETTING

Press <SYS MENU> key, then press ◀ or ▶ key until the screen displays as below.

a) Press ▼, and then enter lock Setting Menu. Press ▲ or ▼ key and enter Lock System > Set Password > Block Program > Parental Guidance.

b) Press ◀ or ▶ Key to access and adjust Lock System > Set Password > Block Program > Parental Guidance.

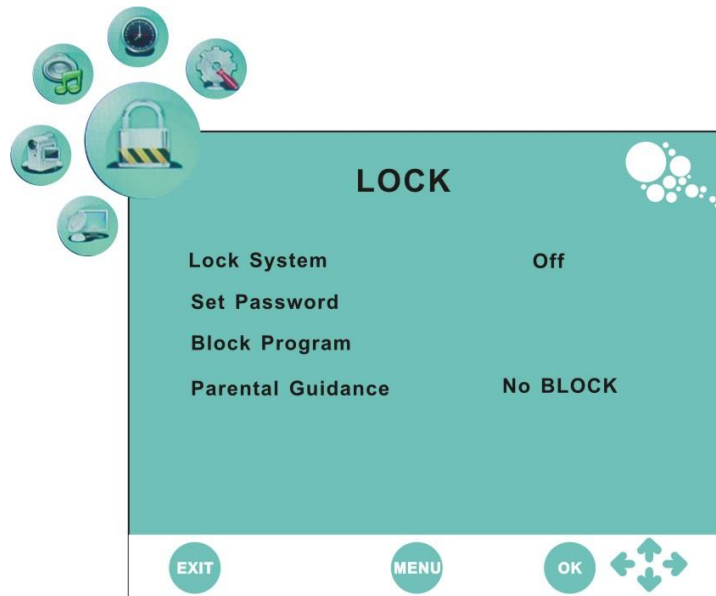

6 REMOTE CONTROL INSTRUCTIONS

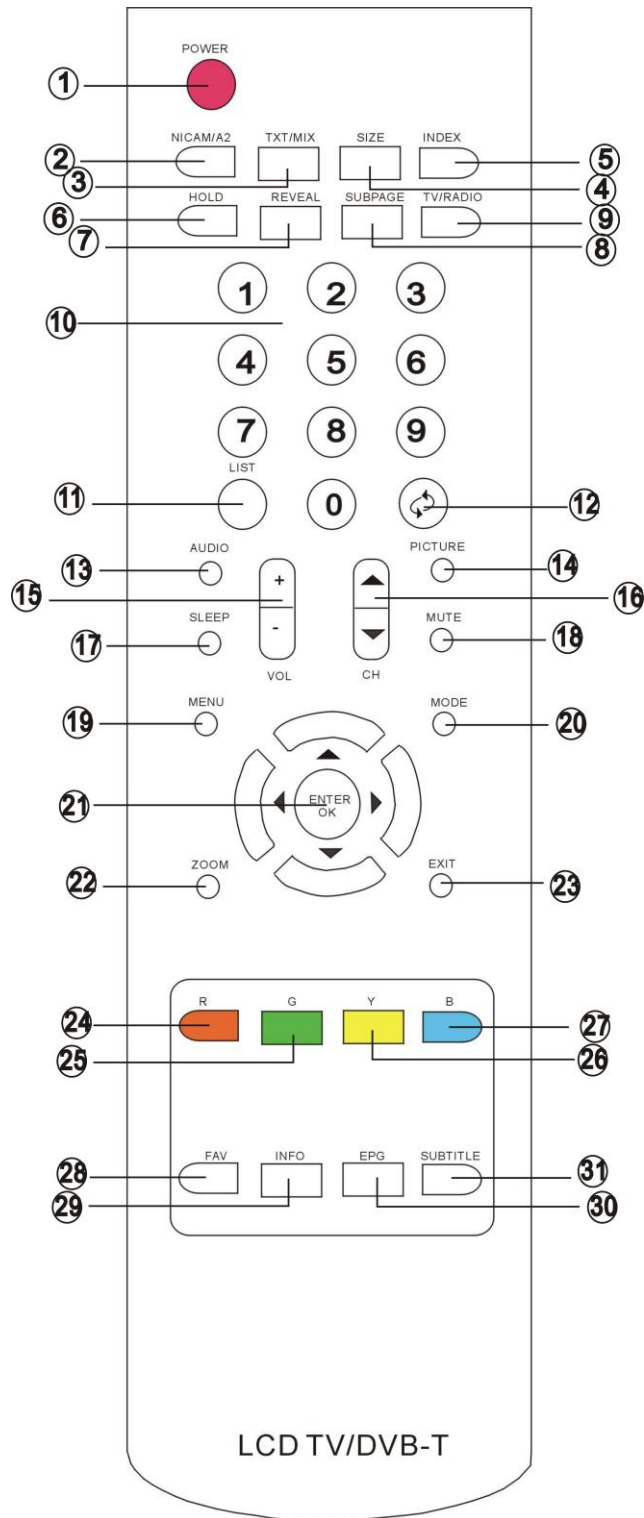

Remote control instructions

- 1.POWER:** Press this button to switch the receiver in and out of standby mode
- 2. NICAM/A2 :** Stereo, Mono, Dual audio
- 3.TXT/MIX :**Shift between TV and Teletext, you can watch the teletext information (For DVB-T and angle TV).
- 4/5/6/7. SIZE/ INDEX/HOLD/ REVEL :**TXT function
- 8. SUBPAGE:** TXT function
- 9. TV/Radio (BROSE / TV/📺) :** Press this button to switch between TV and Radio
- 10. NUMBER KEYS(0-9/-/--):** Press this button to choose the corresponding channel.
- 11.LIST:** channel list.
- 12. ↶:** go back to the last viewed channel
- 13.AUDIO:** Sets the sound mode, standard, movie, news, user
- 14. Picture:** Press to select picture mode
- 15VOL” +”” -”:** Press this button, the volume of TV set increases or decreases
- 16.CHANNEL “+” “-”:** Press this button the number of TV channel increases or decreases.
- 17. Sleep:** Press to select Automatic Switch off
- 18. MUTE:** Press this button, sound disappears, press it again or VOL+ to resume normal sound
- 19. MEUN:** Select the Menu for installation etc. In teletext mode, select sub page mode.
- 20. MODE:** Press MODE to shift the output signal with DTV, TV, AV1, AV2, S-Video, YpbPr, PC, HDMI1, and HDMI2.
- 21. ◀▶ ▲ ▼, ENTER/OK :**
 - ▲ : UP:** These buttons used for orientation direct. In menu status, press these buttons, you can move the cursor from UP to DOWN.
 - ▼ : DOWN:** These buttons used for orientation direct. In menu status, press these buttons, you can move the cursor from DOWN to UP etc.
 - ◀: LEFT:** These buttons used for orientation direct. In menu status, press these buttons, you can move the cursor from LEFT to RIGHT etc.
 - ▶: RIGHT:** These buttons used for orientation direct. In menu status, press these buttons, you can move the cursor from RIGHT to LEFT etc.
- 22.ZOOM:** Change the size of the picture.
- 23. EXIT:** Exit the Menu.
- 24/25/26/27. Red/Green/Yellow/Blue BUTTON:** TXT function
- 28. FAV:** Press this button to jump to your favorite channel list which you stored before (only for DVB-T mode).
- 29. INFO:**In DVB-T mode, Press this button; system will display the information of current program.
- 30. EPG:** Press this button; system will display Electronic Program Guide (only for DVB-T mode)
- 31. SUBTITLE:** Display/OFF the subtitle on screen.

7 REMOTE CONTROL SETUP

- a: Open the cover
- b: AA size batteries, When inserting the batteries, make sure correct polarities as per “+” and “-” marks on the batteries and within the battery compartment
- c: Replace the battery cover

7.1 Battery Usage Caution:

To prevent battery leakage which may result in bodily injury or damage to the remote:

1. Install all batteries correctly, and as marked on the remote control.
2. Do not mix batteries (OLD and NEW or CARBON and ALKALINE, etc.)
3. Remove batteries when the remote is not used for a long time.

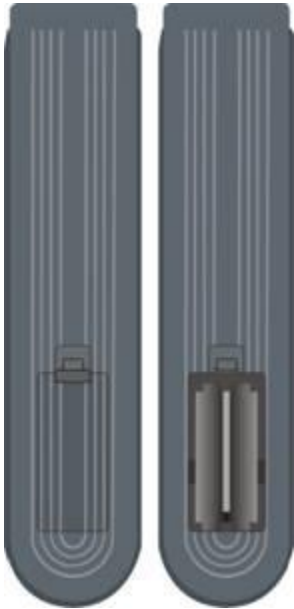

8 ACCESSORIES

1. AC/DC Power Adapter
2. One Remote Control
- 3 1.5V AAA Batteries
4. One User Manual
5. One AV Cable

9 TROUBLE SHOOTING AND ADVICE

Before calling our SAS centre, please check if you can solve the troubleshooting by yourself.

Troubleshooting	Control
No signal	Please check that all cables and cordons are correctly plugged in.
No color shades	Adjust the contrast, the colour and the brightness
Stain show on the screen.	May be result from a lighting signal from car, motor, neon light and other electrical devices or appliances.
Double or multiple display image	May be the result of an electrical wave disturb from other TV, Computer and Game machine or Radio
Snow on the screen	The cables of the antenna are not correctly plugged in.
The remote control does not work	Please check the batteries order and alignment. Check that the IR of the remote control is not hidden by something.
"Zip" made noise on TV cover	Even if the display image is correct, the noise may come from an unsteady fixation of the panel.
No sound	Make sure that you have not pressed the MUTE button of the panel or of the remote control.

10 SPECIFICATIONS:

Screen Size	26 Inch	32 Inch
Display Type	TFT LCD TV	
Resolution(Pixel)	1366*768	
Aspect Ratio	16:9	
Power Source	AC100-240V, 50/60Hz.	
	≤180W	
TV System	PAL/SECAM	
Video Input Format	PAL/NTSC/SECAM	
Antenna Input	Standard antenna socket 75Ω	
Audio Output	L/R 9W*2	
VGA Input Format	Standard VESA Mode	
Input	Video	1.0Vp-p 75 Ω; RCA
	S-Video	Y: 1.0Vp-p±3db C:0. 3Vp-p±3db
	YCbCr/YPbPr	1.0 Vp -p 75 Ω; RCA MAX 1080P/60Hz
	PC INPUT	640*480/@60/72/75HZ,800*600@60/72/75HZ, 1024*768@60/70/75HZ,1280*1024@60/75HZ, 1360*768@60HZ,1440*900/60/75HZ 1600*1200/60/65/75HZ
	HDMI	480i/480p/576i/576p/720p/1080i/1080p
	Audio	500mVrms
Net Weight	13 kg	17kg
Net Dimensions (L * D * H)	682 (L) x 114(D) x 476 (H) mm	
	813 (L) x 255(D) x 618 (H) mm	

The manual is only for your reference; any changes to the design and specification will not be advised.

LCD TV